

Safety cartridge valves type JODL

2-way, poppet type, leak free, with optional inductive position switch conforming to Machine Directive 2006/42/CE

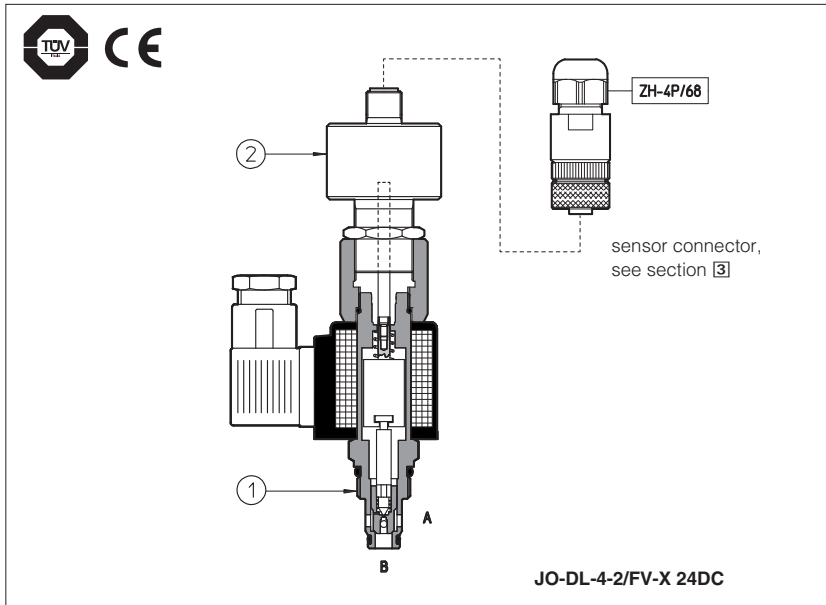

Leak free, poppet type solenoid cartridges in screw-in execution are normally used to cut off the hydraulic power supply line. They are available in normally closed NC, or normally open NO configurations.

The /FV versions integrate an inductive position switch (double contact NC/NO) ② which supplies the output electrical on-off signal indicating the poppet ① position (open/closed), and therefore they can be used as safety valves for emergency conditions.

They are designed to fulfil the safety criteria imposed by the European Machine Directive 2006/42/CE.

For details about the applicable EN standards, see www.atos.com, catalog on line page, section P, table P004.

Features:

- virtually zero internal leakage;
- limited pressure drops;
- low response times;
- great switching reliability even at high pressures and during long rests;
- CE marked and certified by TÜV for /FV version;

Cavity: ISO 17209;
Max flow: 150 l/min;
Max pressure: 350 bar.

1 MODEL CODE

JO	-	D	-	L	-	4	-	2	/	NC	-	X	24DC	**
Cartridge valve screw-in type UNF												Series number		
D = Directional control												12DC = 12 Vdc 24DC = 24 Vdc		
L = Poppet type												X = Without connector see section 3 for available connector		
Size: 4 = 3/4"-16UNF-2B 6 = 7/8"-14UNF-2B 10 = 1 5/16"-12UNF-2B														
2 = Two-way														
Version: NC = normally closed in rest position NO = normally open in rest position FV = normally closed in rest position, with inductive position switch (double contact)														

2 HYDRAULIC CHARACTERISTICS

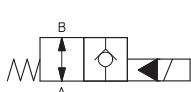
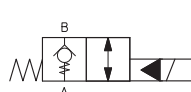
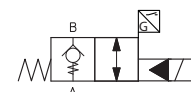
Hydraulic symbols						
/NO		/NC		/FV		
						
Model	JO-DL-4-2/NC JO-DL-4-2/FV	JO-DL-4-2/NO	JO-DL-6-2/NC JO-DL-6-2/FV	JO-DL-6-2/NO	JO-DL-10-2/NC JO-DL-10-2/FV	JO-DL-10-2/NO
Pressure limits [bar]	350					
Nominal flow [l/min]	40		75		150	
Response time: energizing [ms]	35	50	30	50	35	150
de-energizing [ms]	50	35	60	35	70	35
Internal leakage	less than 5 drops/min (≅ 0,36 cm³/min) max at 350 bar					

3 MAIN CHARACTERISTICS OF VALVES TYPE JODL

Installation position	Any position	
MTTFd valves according to EN ISO 13849	150 years, for further details, see technical table P007	
Ambient temperature	From -20°C to + 70°C, from -20°C to +50°C for /FI versions	
Fluid	Hydraulic mineral oil HL, HLP as per DIN 51524 ... 535;	
Recommended viscosity	10 ÷ 100 mm ² /s - max allowed range 2,8 ÷ 500 mm ² /s	
Fluid contamination class	ISO 4406 class 21/19/16 NAS 1638 class 10, in line filters of 25 µm (β ₂₅ ≥ 75 recommended)	
Fluid temperature	From -20°C to + 80°C	
Flow direction	As shown in the symbols of table 2	
Operating pressure	Ports A, B: 350 bar	
Rated flow	See diagrams Q/Δp at section 7	
Maximum flow	40 l/min for JO-DL-4; 75 l/min for JO-DL-6, 150 l/min for JO-DL-10	
Relative duty factor	100%	
Supply voltage	See model code at section 1	
Supply voltage tolerance	±10%	
Max power	19 Watt	
Power connector	666 (plastic - black); 3 pins, cable clamp PG11, cable max ø 11 mm	to be ordered
Type of connector for /FV version	Type ZH-4P-68 (plastic); 4 pins, cable clamp PG9, cable max ø 8 mm	separately
Connectors features	666: DIN 43650 - ISO 4400; IP65 (DIN 40050); VDE 0110C	
	ZH-4P/68: M12 - IEC60947-5-2; IP65 (DIN 40050)	

4 INSTALLATION NOTES

- The assembling of cartridges inside manifolds must be done tightening the valve exagonal ring (for tightening torque, see section 8). Excessive values can cause anomalous deformation and poppet sticking. For the /FV versions avoid to tighten through the position sensor.
- The CE certification is valid only with shielded electric cables and connector. Consult also tab. P004. These safety valves must be supplied only and always as one complete component, proximity sensor is factory adjusted. The supply of subcomponents invalidates the certification.

5 TECHNICAL CHARACTERISTICS AND CONNECTING SCHEME OF INDUCTIVE POSITION SWITCH /FV

Type of switch	position switch /FV	
Supply voltage [V]		20÷32
Ripple max [%]		≤ 10
Max current [mA]		400
Power consumption [mA]		-
Voltage drop [V]		-
Max switching frequency [Hz]		-
Max peak pressure [bar]		400
Mechanical life		virtually infinite
Switch logic		PNP

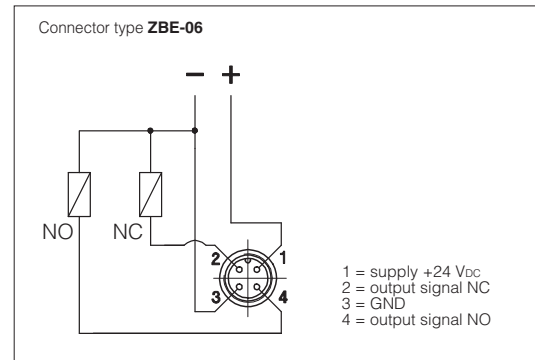

NOTE: the /FV position switch are not provided with a protective earth connection

6 SIGNAL STATUS - VERSIONS /FV

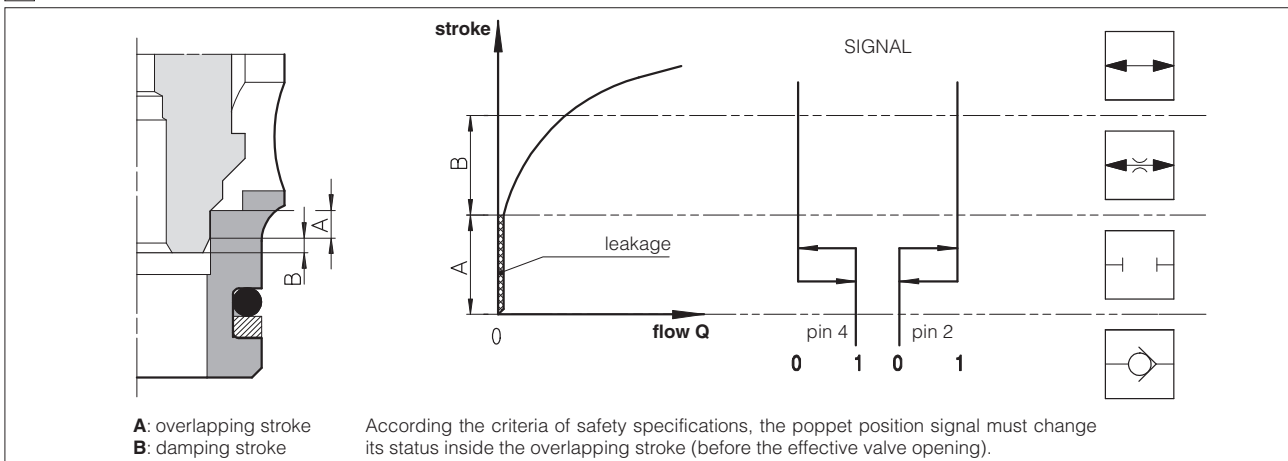

7.1 JO-DL-4

Valve pressure drop - NO version
1 = flow B → A
2 = flow A → B

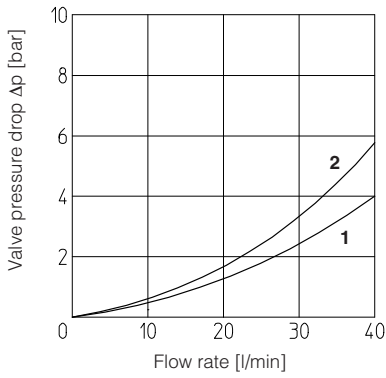

Valve pressure drop - NC version
3 = flow B → A energized
4 = flow A → B
5 = flow B → A de-energized

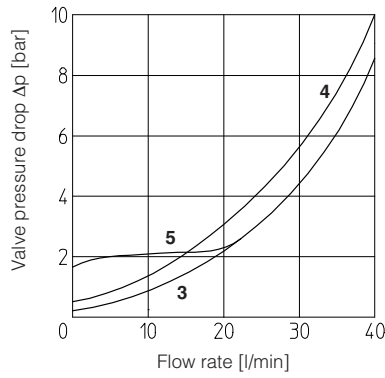

Valve pressure drop - FV version
6 = flow B → A energized
7 = flow A → B
8 = flow B → A de-energized

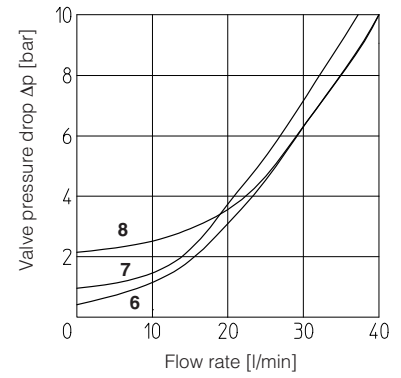

7.2 JO-DL-6

Valve pressure drop - NO version
1 = flow B → A
2 = flow A → B

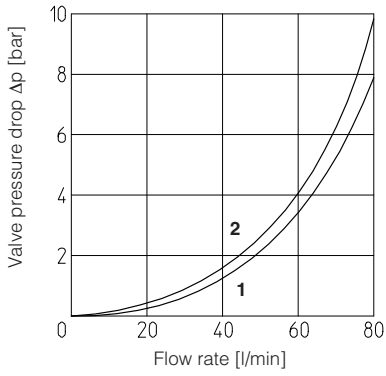

Valve pressure drop - NC version
3 = flow B → A energized
4 = flow A → B
5 = flow B → A de-energized

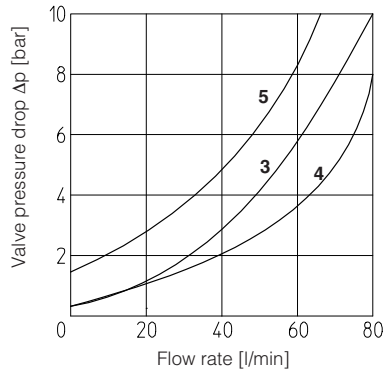

Valve pressure drop - FV version
6 = flow B → A energized
7 = flow A → B
8 = flow B → A de-energized

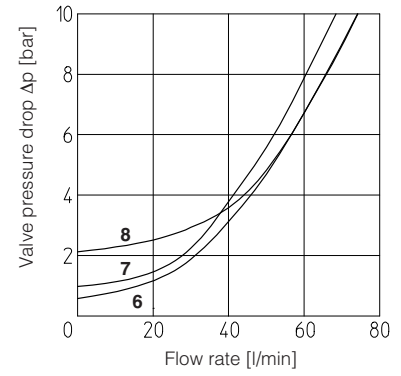

7.3 JO-DL-10

Valve pressure drop - NO version
1 = flow B → A
2 = flow A → B

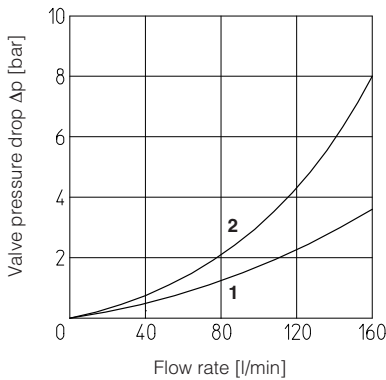

Valve pressure drop - NC version
3 = flow B → A energized
4 = flow A → B
5 = flow B → A de-energized

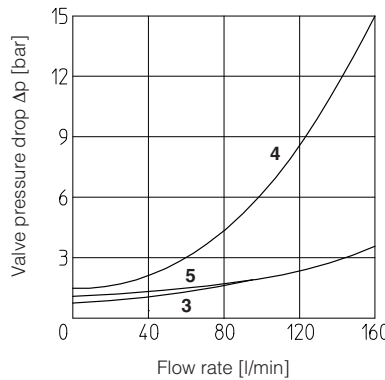

Valve pressure drop - FV version
6 = flow B → A energized
7 = flow A → B
8 = flow B → A de-energized

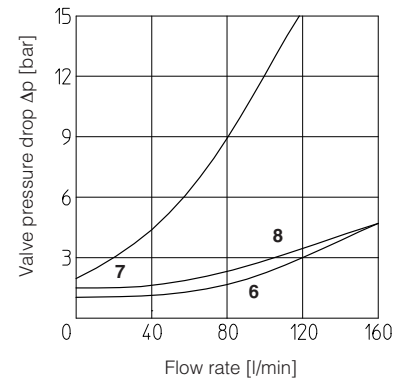

JO-DL-4

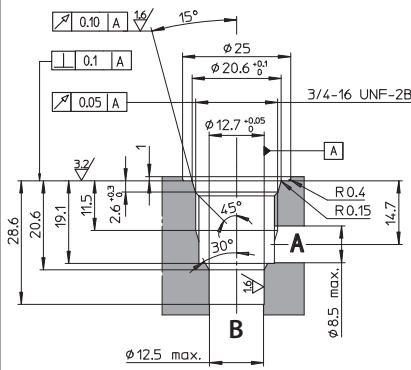

Version /NO

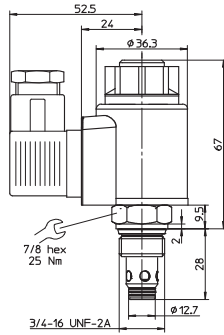

Version /NC

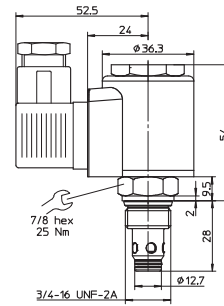

Version /FV

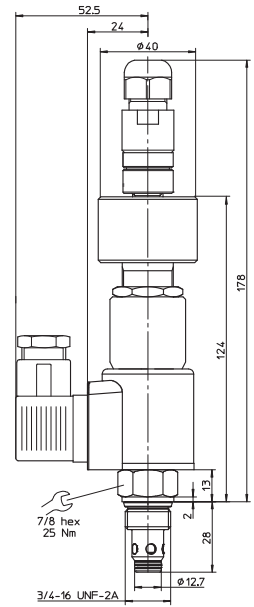

JO-DL-6

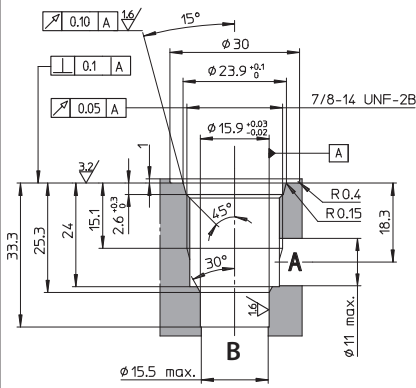

Version /NO

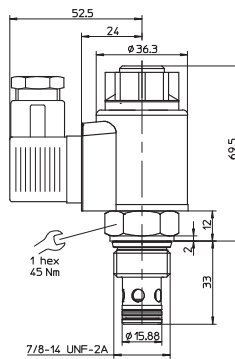

Version /NC

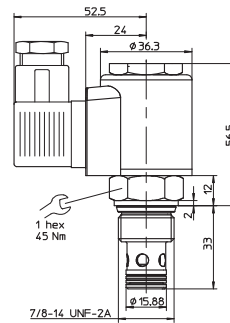

Version /FV

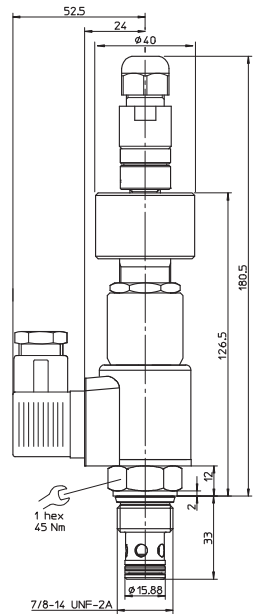

JO-DL-10

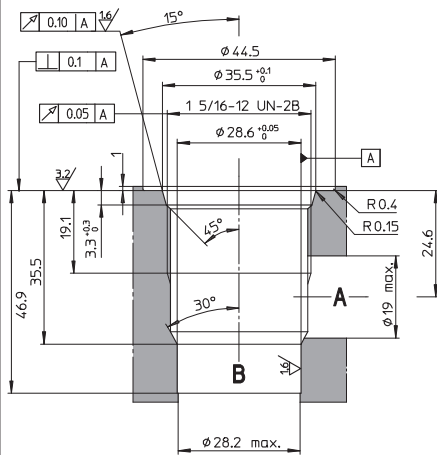

Version /NO

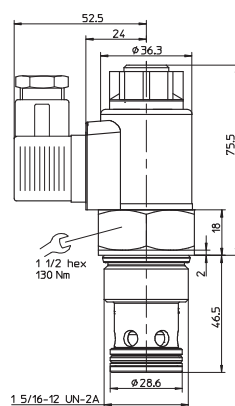

Version /NC

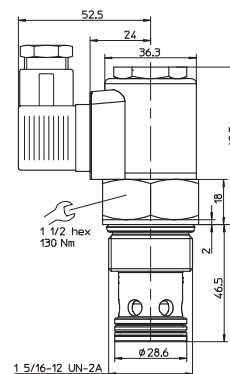

Version /FV

